

2/2-Wege Stellungsregelventil 2/2-way proportional valve

Baureihe 788 - 20 Type 788 - 20

elektromotorisch gesteuert electromotive controlled

Elektromotorisches Stellungsregelventil
mit Handnotverstellung und mechanischer Stellungsanzeige

*electromotive controlled proportional valve with manual override
and position indicator*

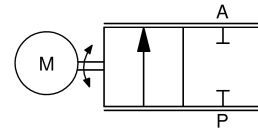

Elektrischer Anschluss / electrical connection

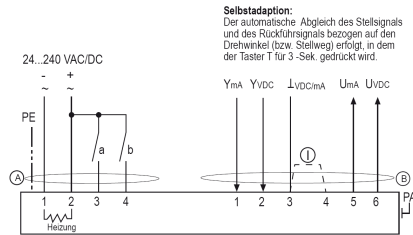

Funktion und Zwangssteuerung:
- a geschlossen, Zwangs Auf (Zu) - je nach links/rechts Montage des Antriebs
- b geschlossen, Zwangs Zu (Auf) - je nach links/rechts Montage des Antriebs

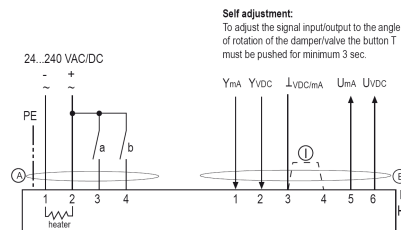

Function of switch a and b:
- a closed, On (Off) - in acc. to left/right mounting of the actuator
- b closed, Off (On) - in acc. to left/right mounting of the actuator

Bauart	stufenlose Positionsregelung	design	stepless position regulation
Medien	flüssig – gasförmig – hochviskos (50µ)	media	liquid – gaseous – highly viscous (50µ)
Nennweite	DN 20	diameter	DN 20
Druckbereich	0 – 120bar	pressure range	0 – 120bar
Gehäusewerkstoff	Messing; 1.4305; 1.4571	body material	brass; AISI 303; AISI 316
Dichtwerkstoff	statisch: FKM dynamisch: FKM, PTFE Sitzdichtung: PTFE	seal	static: FKM dynamic: FKM, PTFE seat seal: PTFE
Temperatur	Medium: -20 bis +80°C Umgebung: -40 bis +50°C	temperature	media: -20 up to +80°C ambient: -40 up to +50°C
Anschluss	Muffengewinde G1/2, G3/4, G1	connections	threads G1/2, G3/4, G1
Elektr. Anschluss	2x Anschlusskabel 1m lang	electr. connection	2x connector cable 1m long
Anschlussspannung	24V – 230V DC /AC (50 – 60Hz)	nominal voltage	24V – 230V DC /AC (50 – 60Hz)
Spannungstoleranz	+15% / -20%	voltage tolerance	+15% / -20%
Leistungsaufnahme	ca. 20W (40W peak)	power consumption	ca. 20W (40W peak)
Stromaufnahme	ca. 1,6A (peak) bei 24V DC und 7,5s	current consumption	ca. 1,6A (peak)@24VDC and 7.5s
Einschaltdauer	100% ED	duty factor	100% ED
Schutzart	IP 65	protection class	IP 65
Steuersignal	0 – 10V@10KΩ, 4 – 20mA @100Ω, 3-Pkt.	control signal	0 – 10V@10KΩ, 4 – 20mA@100Ω, 3-point
Rückführsignal	0 – 10V, 4 – 20mA	feedback signal	0 – 10V, 4 – 20mA
Optionen	Ex-Schutz, Federrücklauf	options	explosion-proof, spring return

2/2-Wege Stellungsregelventil
2/2-way proportional valve
Baureihe 788 - 20
Type 788 - 20

DN [mm]	Druck pressure range [bar]	K _v -Wert flow rate [m ³ /h]	Stellzeit ZU – AUF (einstellbar) operating time shut – open (selectable) [sec]	Gewicht (Messing) weight (brass) [kg]
20	120	9,4	7,5 /15 /30 /60 /120	7,5

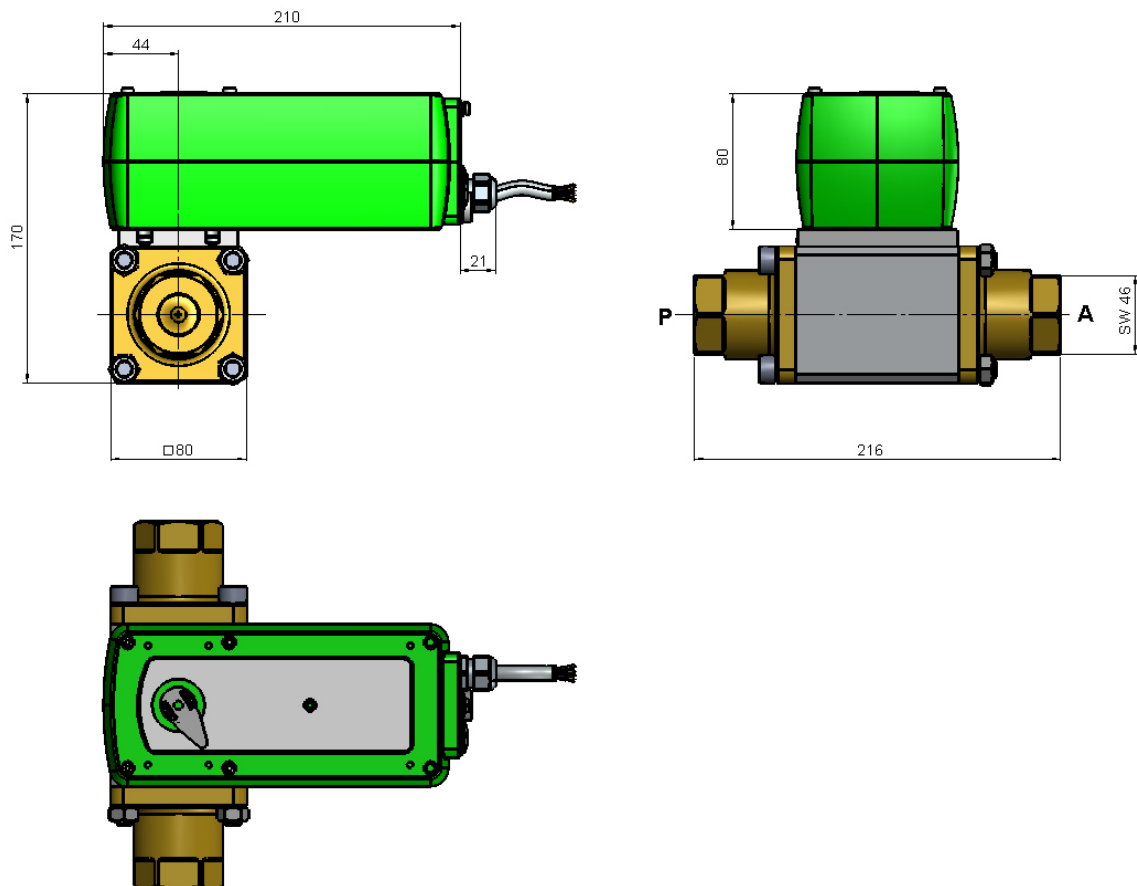
Maßzeichnung
dimensional drawing

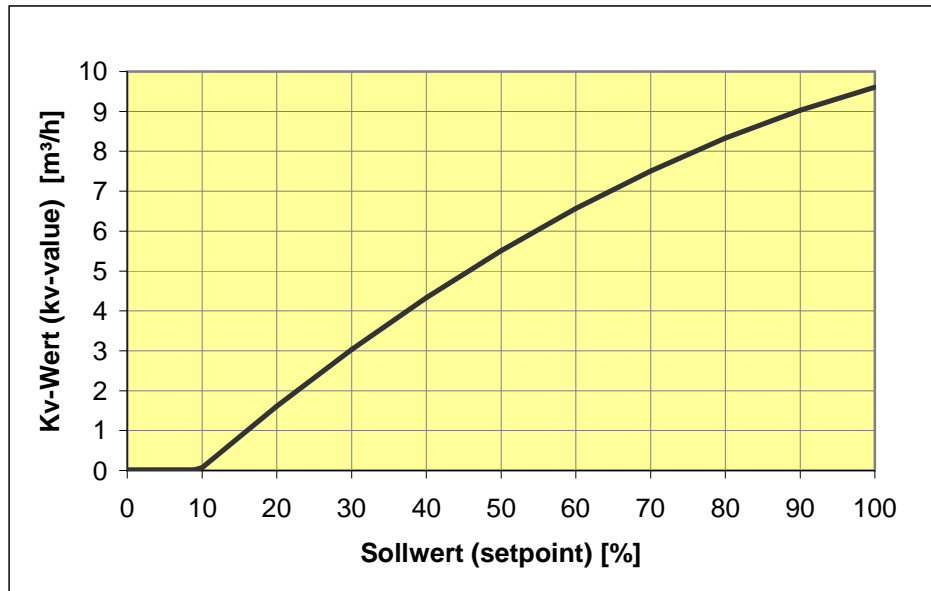

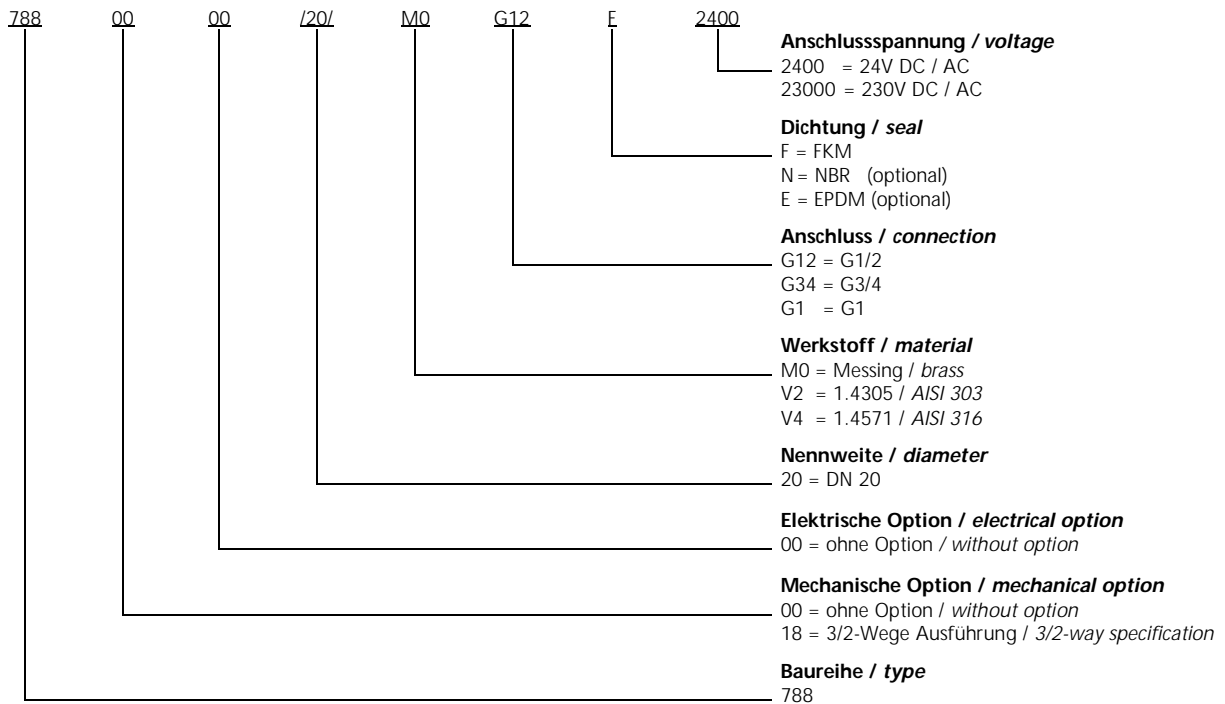

Typenschlüssel type code

Die Typenbezeichnung setzt sich zusammen aus:
 structure of the order specification:

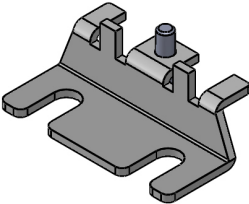
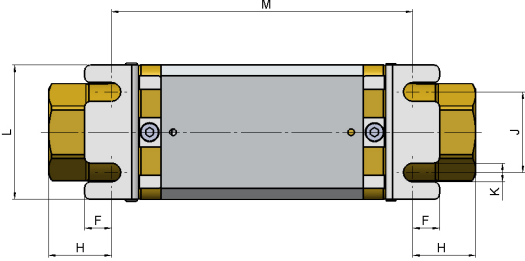

2/2-Wege Stellungsregelventil
2/2-way proportional valve
Baureihe 788 - 20
Type 788 - 20
Zubehör
accessories

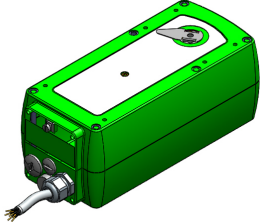
	<p>Haltewinkel <i>mounting brackets</i></p> <p>mechanische Option = 15 <i>mechanical option = 15</i></p>	 <table border="1" data-bbox="823 846 1433 943"> <thead> <tr> <th>DN [mm]</th> <th>F [mm]</th> <th>H [mm]</th> <th>J [mm]</th> <th>K [mm]</th> <th>L [mm]</th> <th>M [mm]</th> </tr> </thead> <tbody> <tr> <td>20</td> <td>15,3</td> <td>33,5</td> <td>50</td> <td>7</td> <td>80</td> <td>149</td> </tr> </tbody> </table>	DN [mm]	F [mm]	H [mm]	J [mm]	K [mm]	L [mm]	M [mm]	20	15,3	33,5	50	7	80	149
DN [mm]	F [mm]	H [mm]	J [mm]	K [mm]	L [mm]	M [mm]										
20	15,3	33,5	50	7	80	149										
	<p>Sonderschutzart <i>explosion proof</i></p> <p>II 2G EEx d ia IIC T6/T5 II 2D IP66 T80°C</p> <p>elektrische Option = 13 <i>electrical option = 13</i></p>															
	<p>Federrücklauf <i>spring return</i></p> <p>elektrische Option = 14 <i>electrical option = 14</i></p>															

Weitere Optionen und Zubehör stimmen wir gerne auf Ihre Anforderungen ab.
We gladly coordinate further options and accessories according to your requirements.